

Exploring God's Word

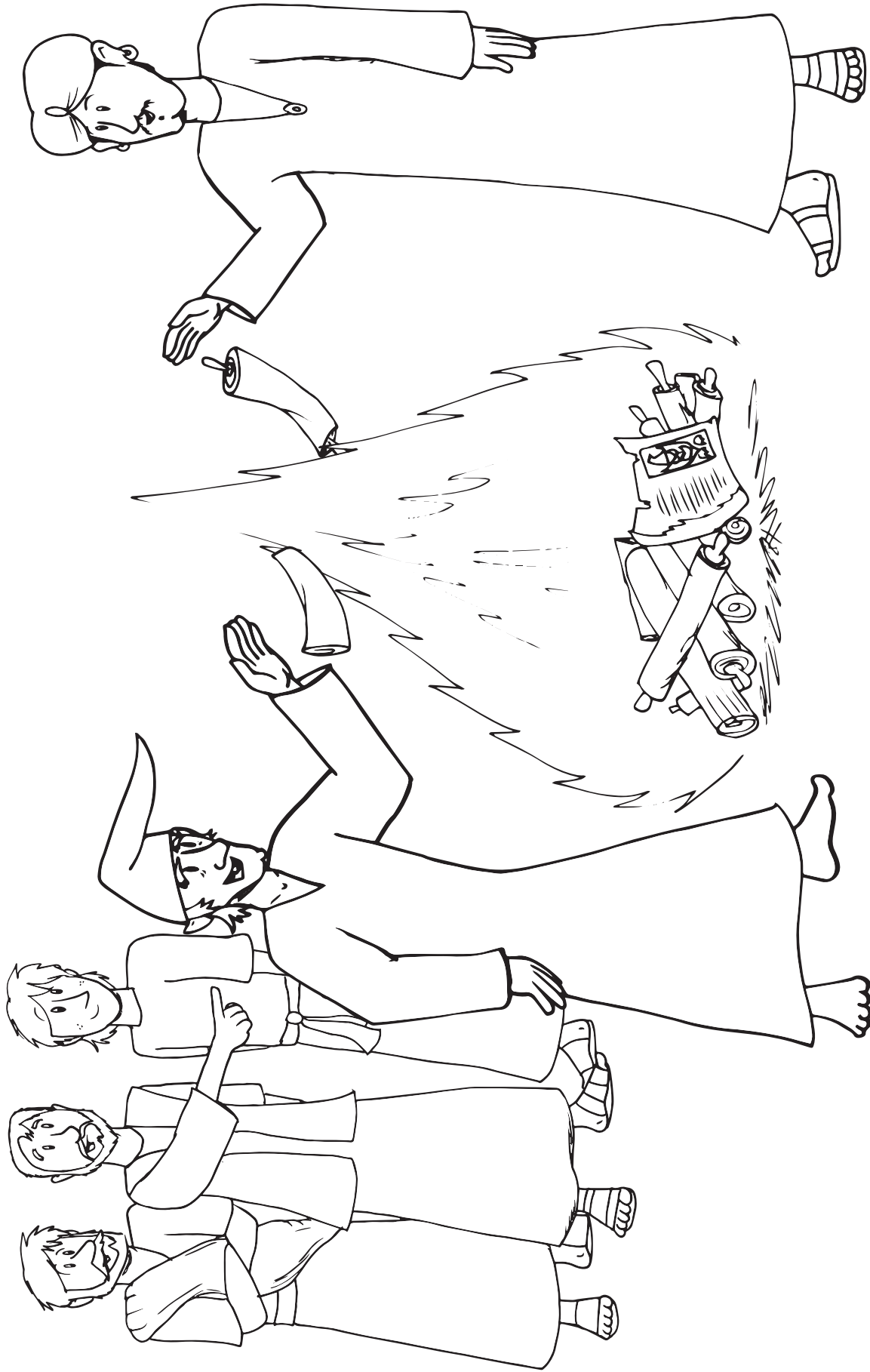

Activity Book New Testament 8 **LESSON 7**

Magic Books Burning Coloring Sheet



“Also, many of those who had practiced magic brought their books together and burned them in the sight of all. And they counted up the value of them, and it totaled fifty thousand pieces of silver. So the word of the Lord grew mightily and prevailed” (Acts 19:19-20).

Speaking Out Against Witchcraft



S

19

Exploring God's Word



Activity Book New Testament 8 **LESSON 8**

Paul Preaches in Troas Coloring Sheet



“Now on the first day of the week, when the disciples came together to break bread, Paul...spoke to them and continued his message until midnight.... And in a window sat a certain young man named Eutychus, who was sinking into a deep sleep...and as Paul continued speaking, he fell down from the third story and was taken up dead” (Acts 20:7-9).

Terrible Fall in Troas



T

20

"T" Sewing Cutouts

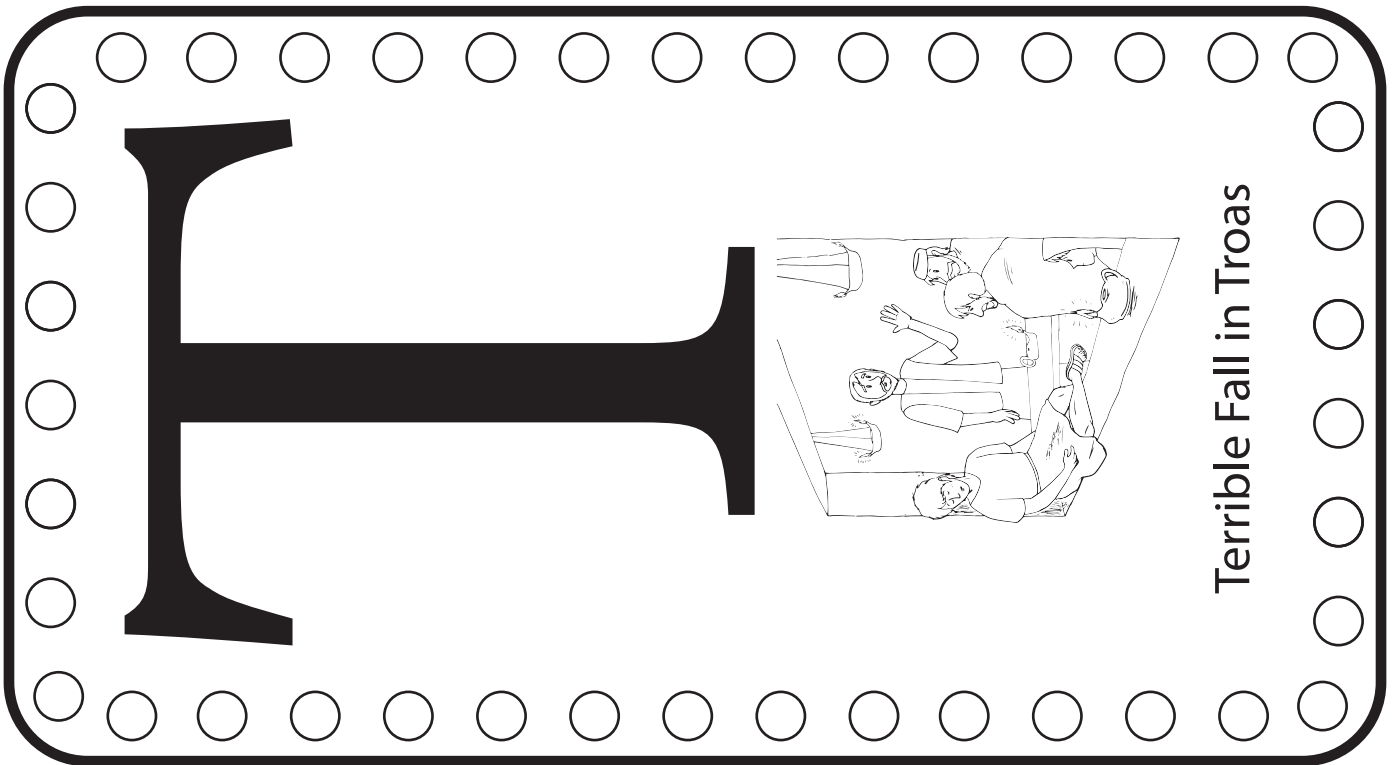
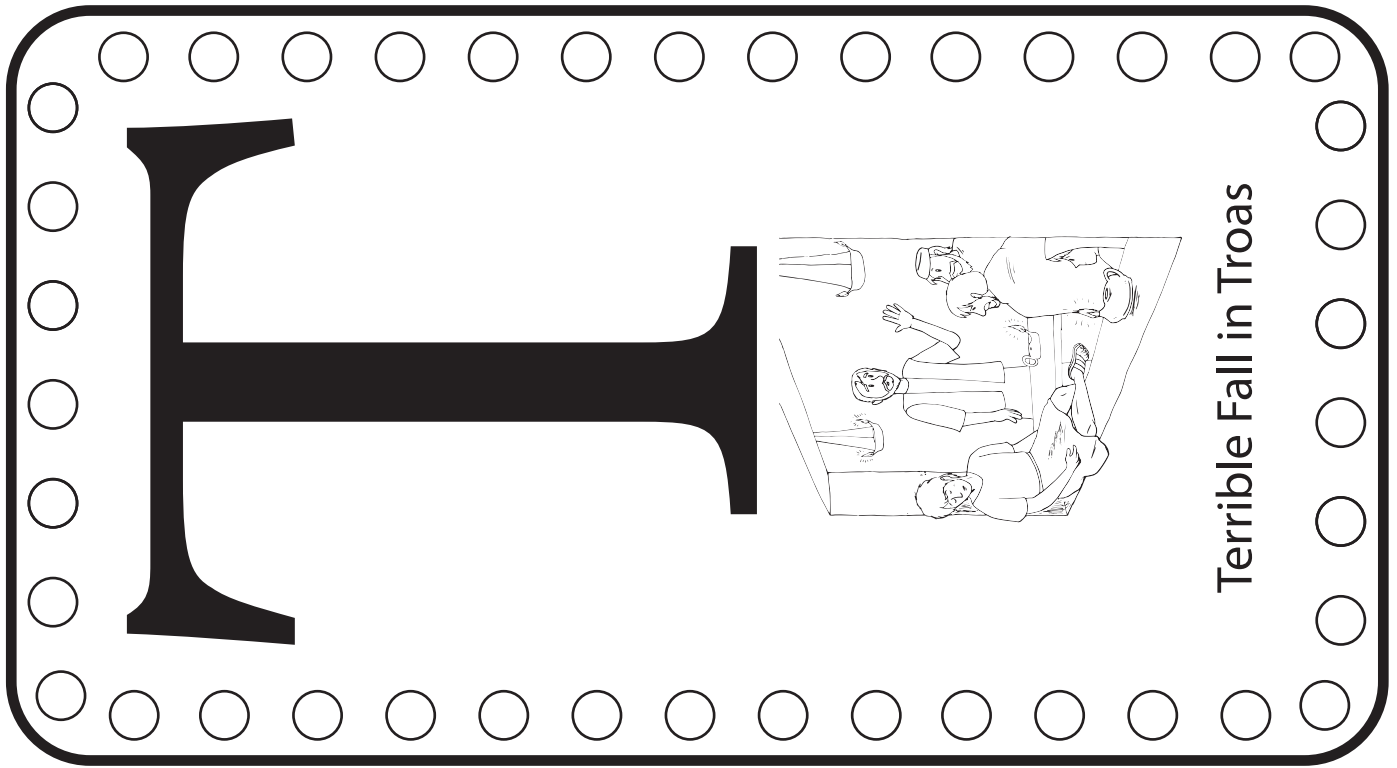

Index Cards

Paul

Eutychus

Breaking
Bread

Sleep

Death

Preaching

Window

Troas

Exploring God's Word



Activity Book New Testament 8 **LESSON 9**

Uproar In Jerusalem Coloring Sheet



“He immediately took soldiers and centurions, and ran down to them. And when they saw the commander and the soldiers, they stopped beating Paul” (Acts 21:32).

Uproar in Jerusalem; Valiant Defense



U & V

21-22

Acts

Word Scramble

1) PRRAUO

2) RUELAMSJE

3) UALP

4) AESMJ

5) DOGO SNWE

6) SNATISIHRC

7) NILTESGE

8) ANORM

9) RGKEE

10) SATC

Shield Cutout

Ages 2-5

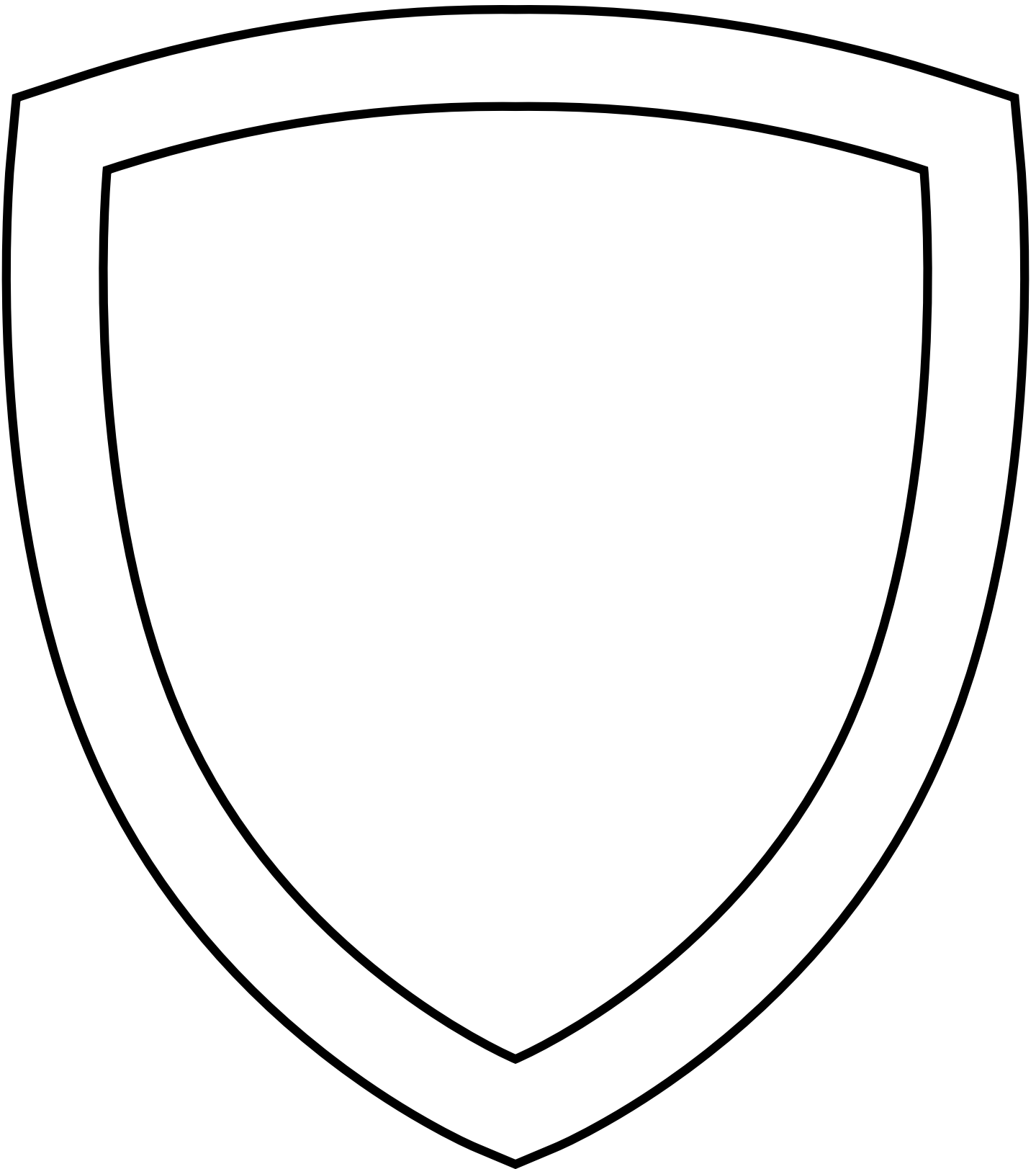

Answer Key

Word Scramble

- 1) Uproar
- 2) Jerusalem
- 3) Paul
- 4) James
- 5) Good News
- 6) Christians
- 7) Gentiles
- 8) Roman
- 9) Greek
- 10) Acts

Exploring God's Word



Activity Book New Testament 8 **LESSON 10**

Waiting to Kill Paul Coloring Sheet

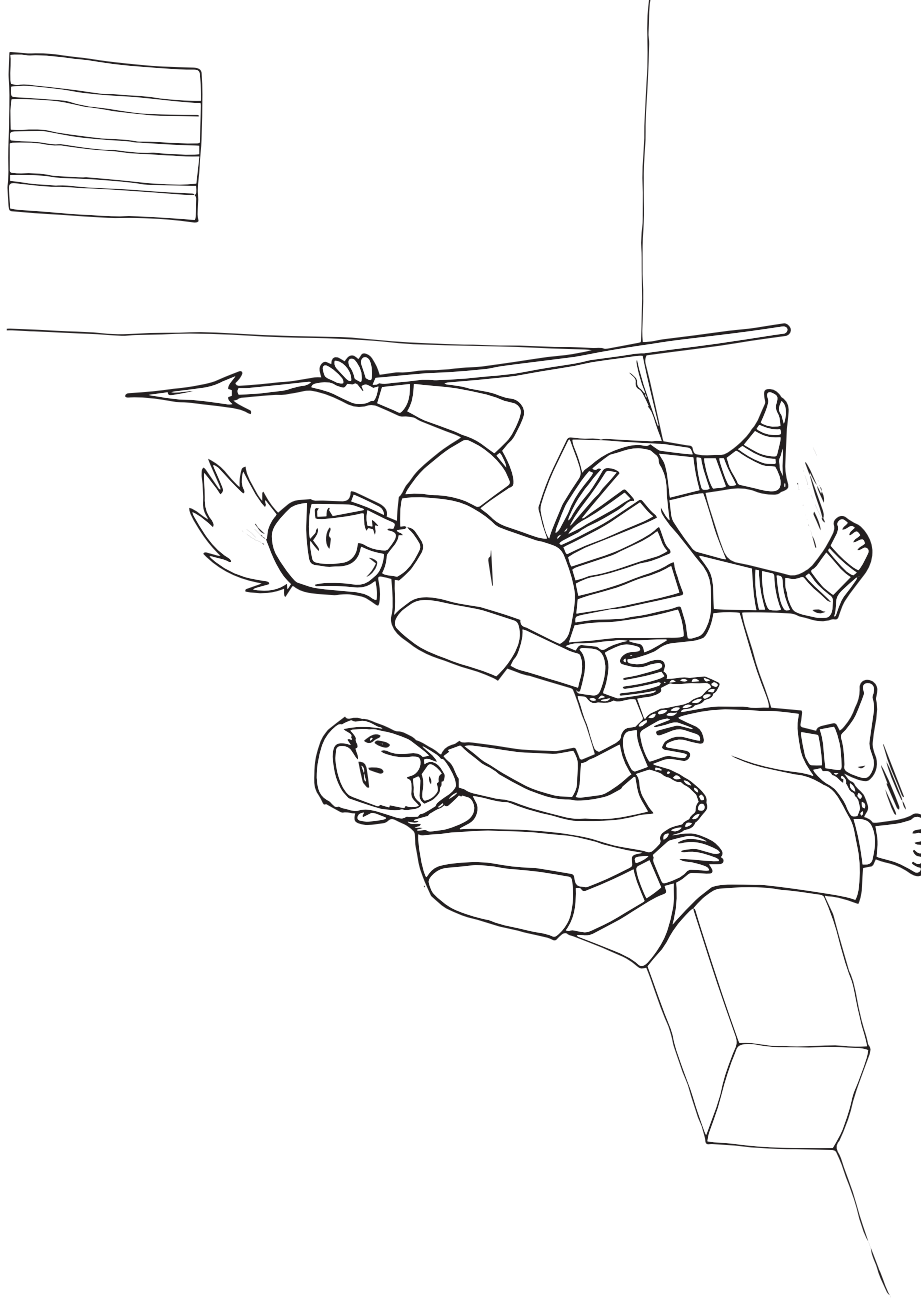

“The next day, because he wanted to know for certain why he was accused by the Jews, he released him from his bonds, and commanded the chief priests and all their council to appear, and brought Paul down and set him before them” (Acts 22:30).

Waiting to Kill Paul; X-treme Charges Against Paul

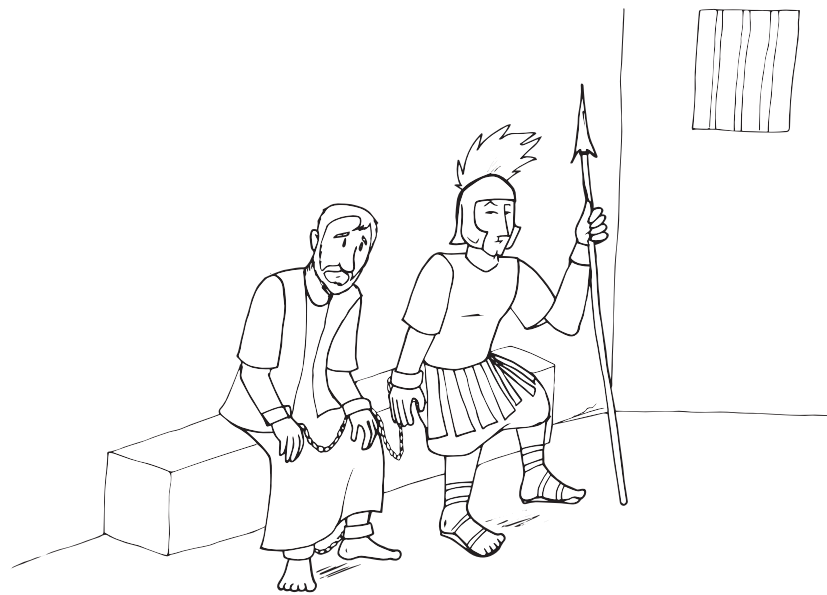

W & X 23-24

Waiting to Kill Paul

Word Search

Instructions: Find and circle the words from the word bank. As you search for the words, think about what those words have to do with the lesson.

B A Y P H M E J L U G L K
 L L W S O A E D O T N K O
 W H I G H S R E V D B D H
 A J X H U P O Y J U G K T
 C L J S E X A N A N I A S
 Z K K G R G T R I A L T O
 J A Y O H E K T S M Q U V
 P A M A L O I L T E R O B
 R E P U W A L D L O D R Y
 Z W M Z W M L Y L U A P O
 G X L F M T U N G O D L Y
 W H S U R N Y X R U S U D
 S F M D F E W T T C C S M

Ananias
 Holy
 Jesus
 Kill
 Old Law
 Paul

Waiting
 Rome
 Soldiers
 Trial
 Ungodly

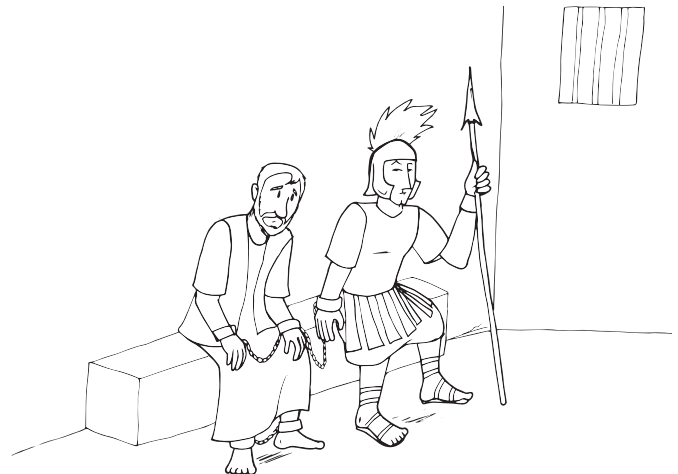

Answer Key

B A Y P H M E J L U G L K
 L L W S O A E D O T N K O
 W H I G H S R E V D B D H
 A J X H U P O Y J U G K T
 C L J S E X A N A N I A S
 Z K K G R G T R I A L T O
 J A Y O H E K T S M Q U V
 P A M A L O I L T E R O B
 R E P U W A L D L O D R Y
 Z W M Z W M L Y L U A P O
 G X L F M T U N G O D L Y
 W H S U R N Y X R U S U D
 S F M D F E W T T C C S M

Ananias

Holy

Jesus

Kill

Old Law

Paul

Waiting

Rome

Soldiers

Trial

Ungodly

Exploring God's Word



Activity Book New Testament 8 **LESSON 11**

Yet Untried by Caesar Coloring Sheet

All Ages

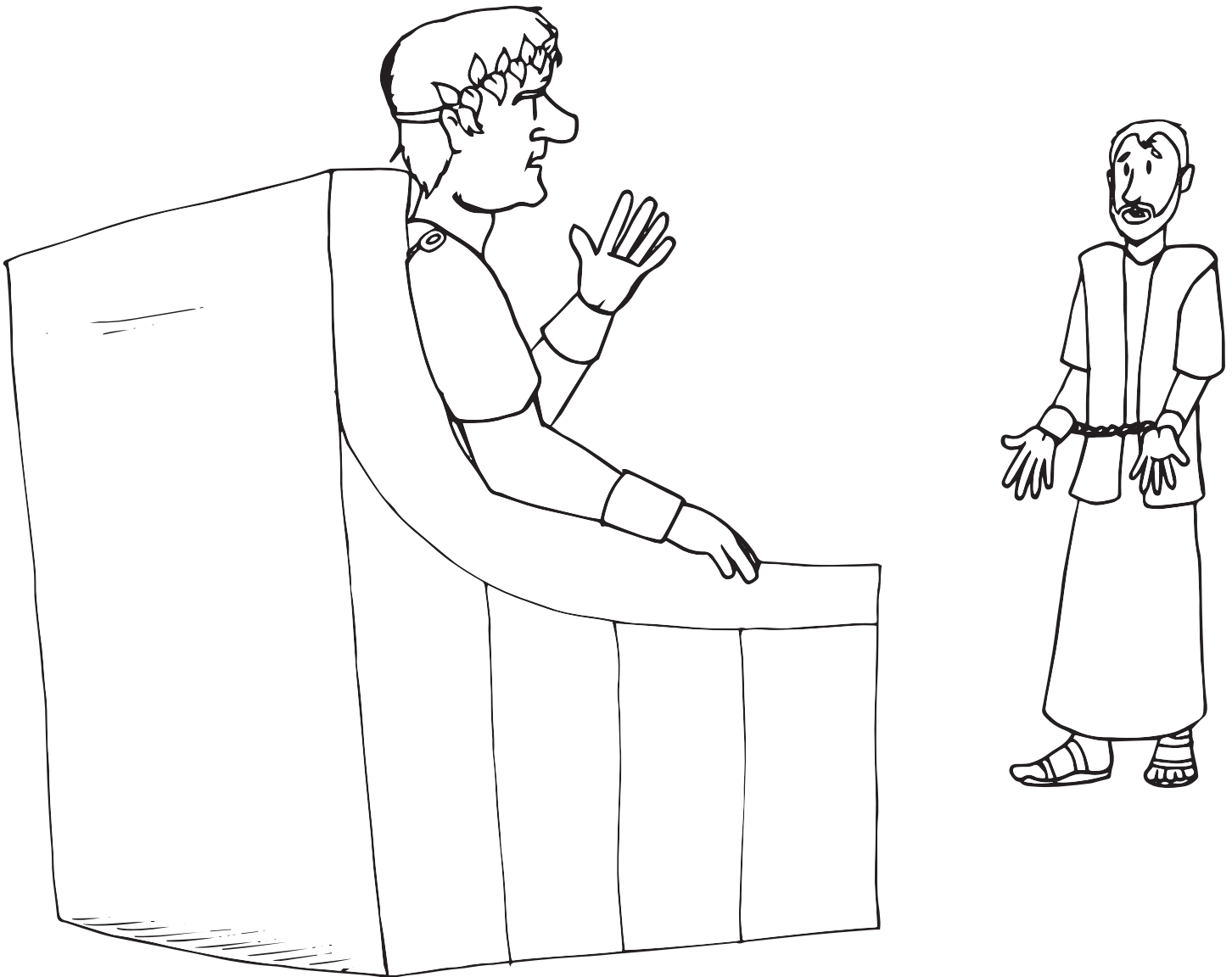

“For if I am an offender, or have committed anything deserving of death, I do not object to dying; but if there is nothing in these things of which these men accuse me, no one can deliver me to them. I appeal to Caesar” (Acts 17:10-11).

Yet Untried by Caesar; Zealous for God Before Agrippa

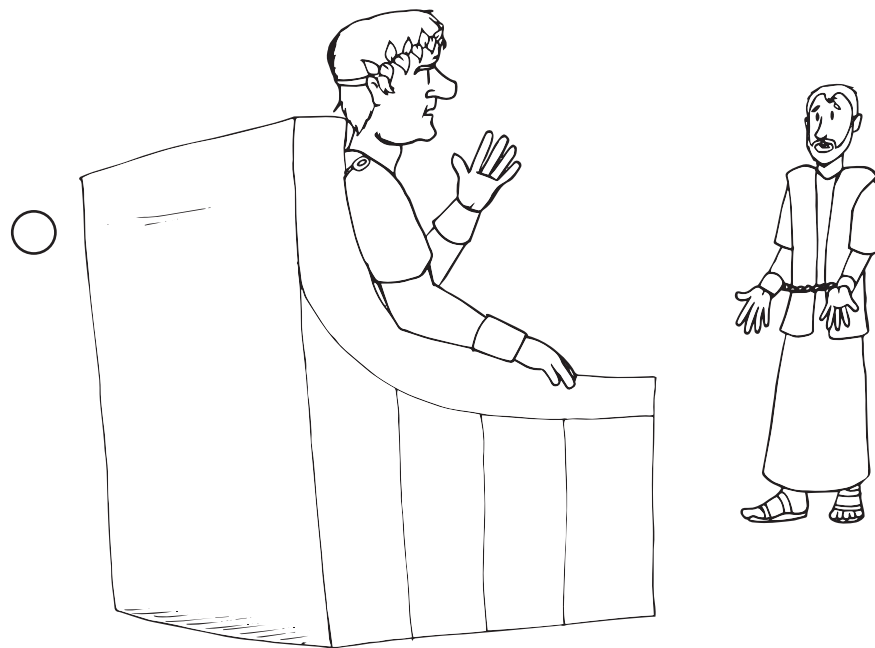

Y & Z **25-26**

Monkey Cutout

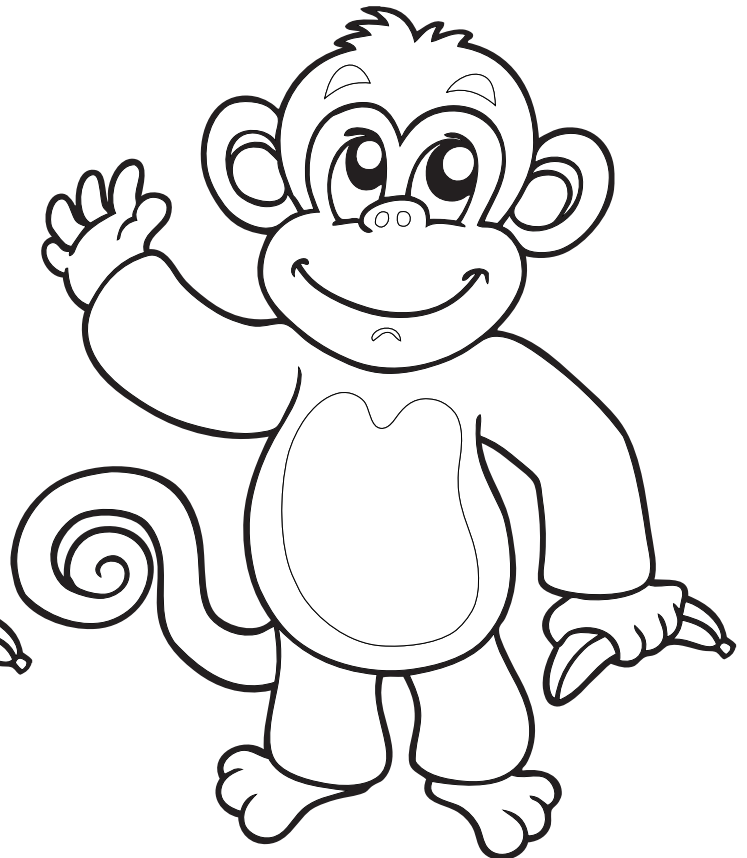
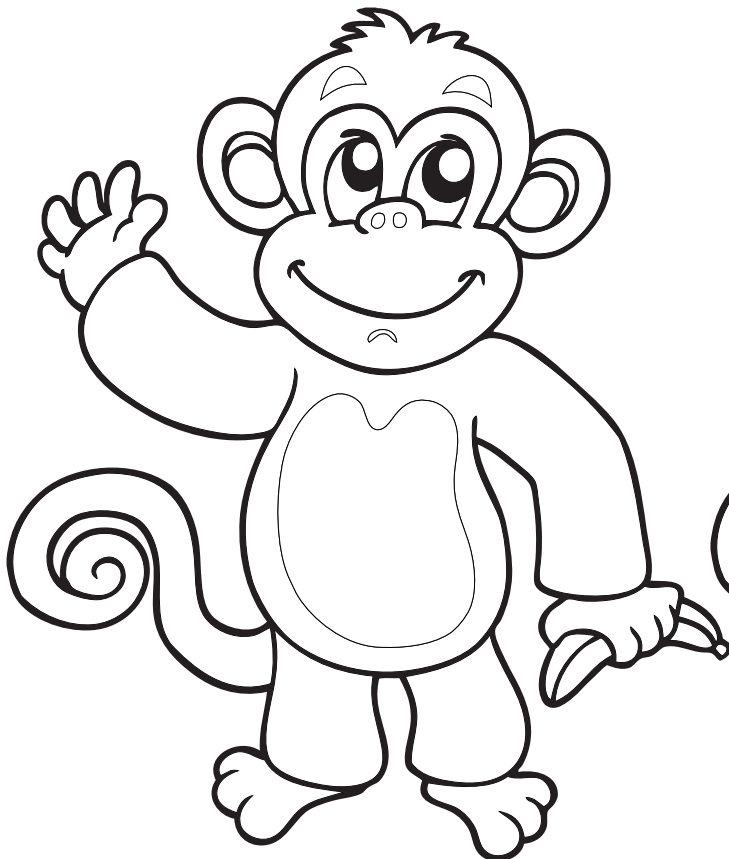
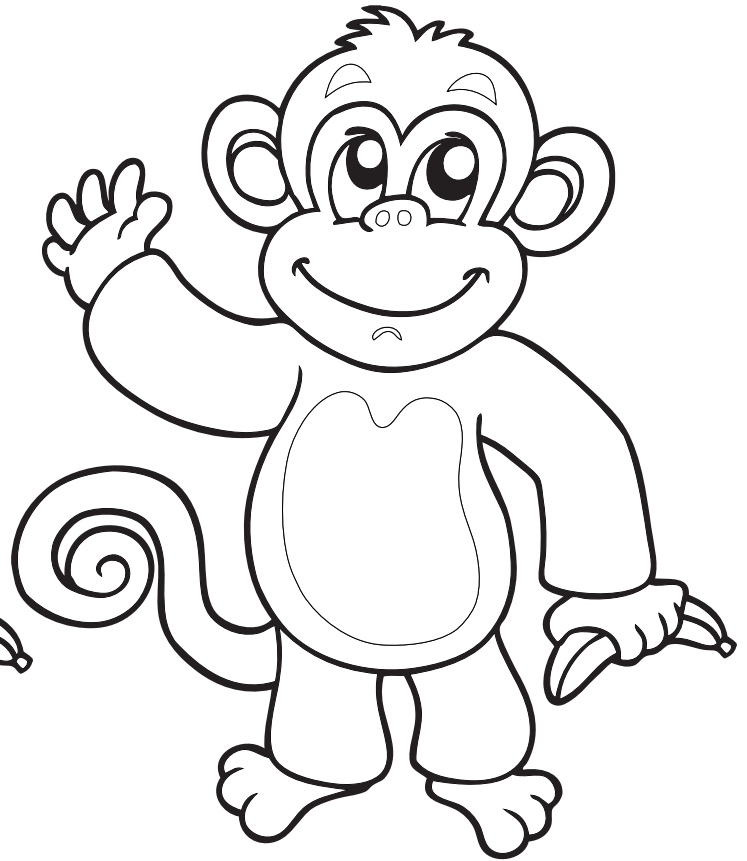
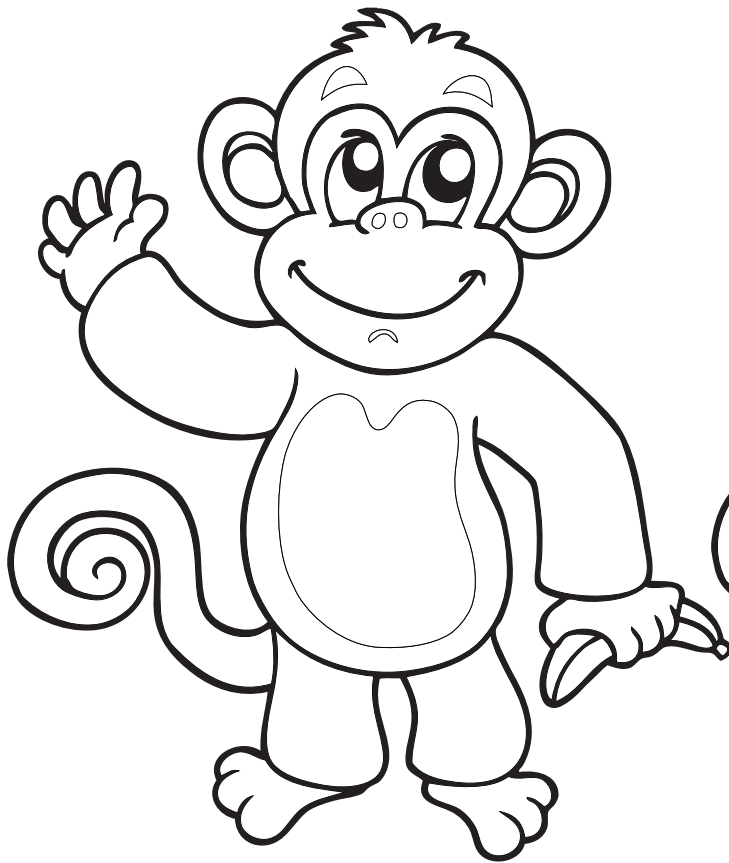

Banana Cutout

1st-4th Grades

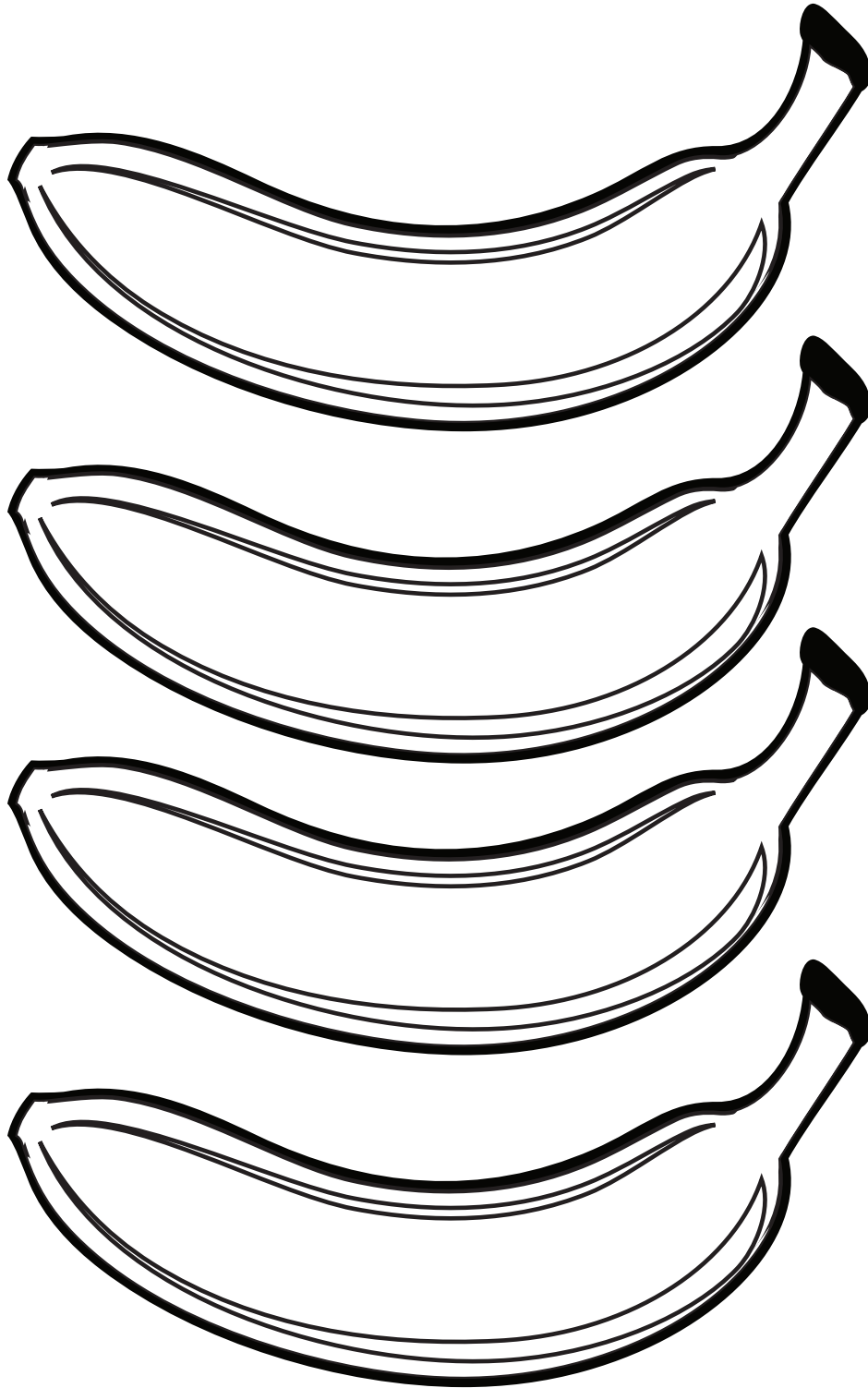

Exploring God's Word



Activity Book New Testament 8 **LESSON 12**

Shipwrecked Coloring Sheet



“But striking a place where two seas met, they ran the ship aground;...the stern was broken up by the violence of the waves.... But the centurion... commanded that those who could swim should jump overboard first and get to land, and the rest, some on boards and some on parts of the ship. And so it was that they all escaped safely to land” (Acts 27:41-44).

Shipwrecked; Safe on Malta; Imprisoned in Rome



27-28

Ship Cutouts

All Ages

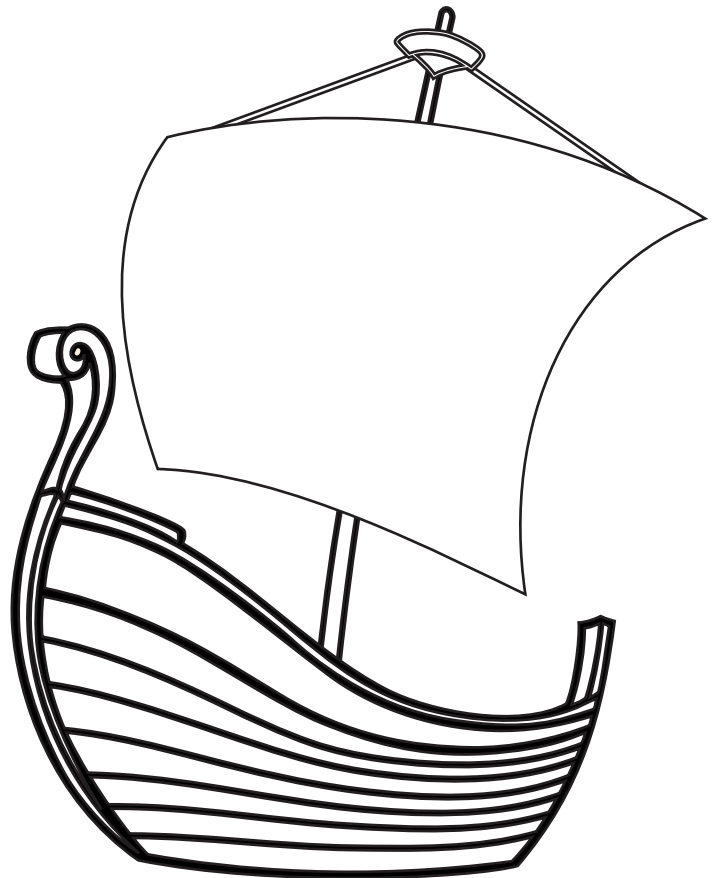
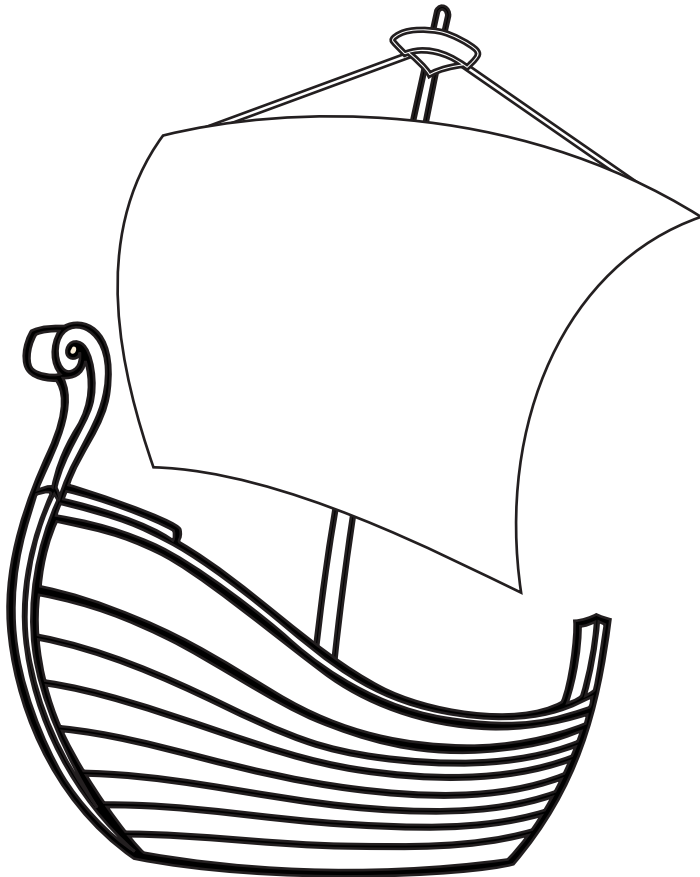
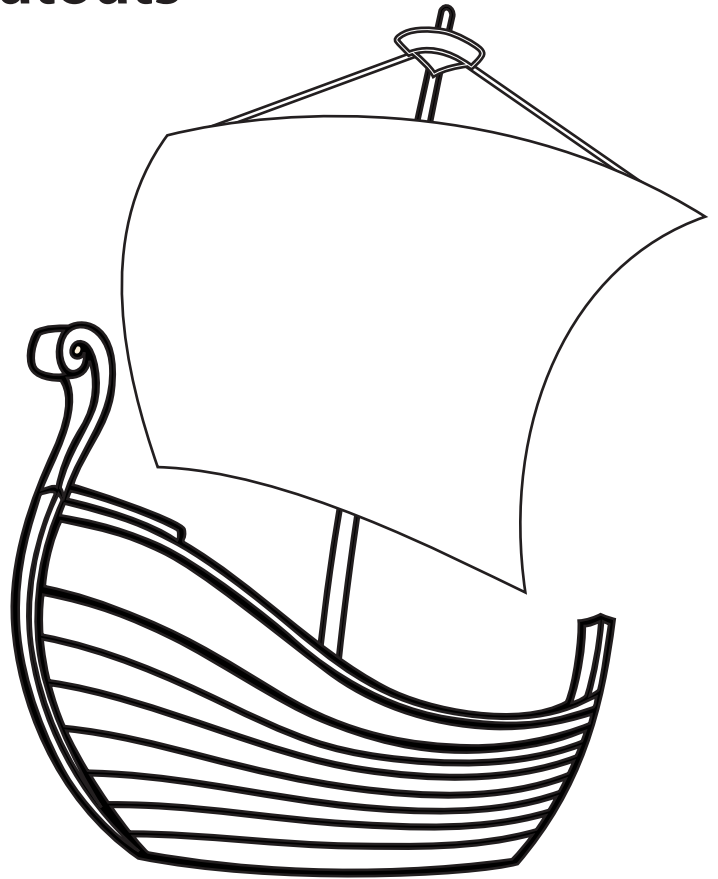
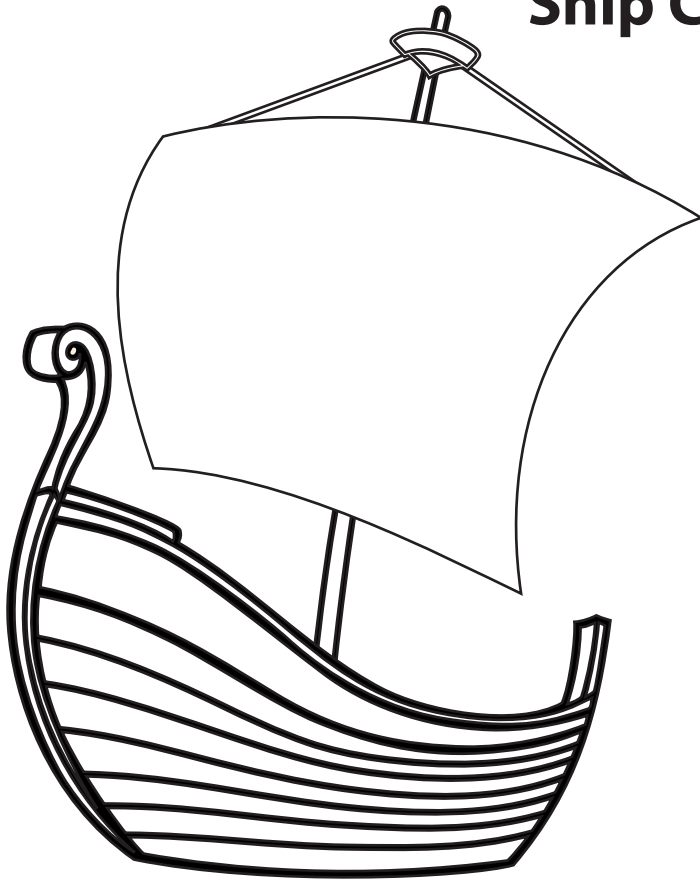

Standing on the Promises Activity

YOU WILL BE
SAVED

CONFESS WITH YOUR MOUTH
THE LORD JESUS, BELIEVE
THAT GOD HAS RAISED HIM
FROM THE DEAD

HE IS FAITHFUL AND JUST TO
FORGIVE US OUR SINS AND
TO CLEANSE US FROM ALL
UNRIGHTEOUSNESS

IF WE CONFESS
OUR SINS

HE IS A NEW CREATION;
OLD THINGS HAVE
PASSED AWAY; BEHOLD,
ALL THINGS HAVE
BECOME NEW

IF ANYONE IS
IN CHRIST

HE WILL DRAW
NEAR TO YOU

DRAW NEAR TO
GOD

HE WHO BELIEVES
AND IS BAPTIZED

WILL BE SAVED

Acts Crossword Puzzle

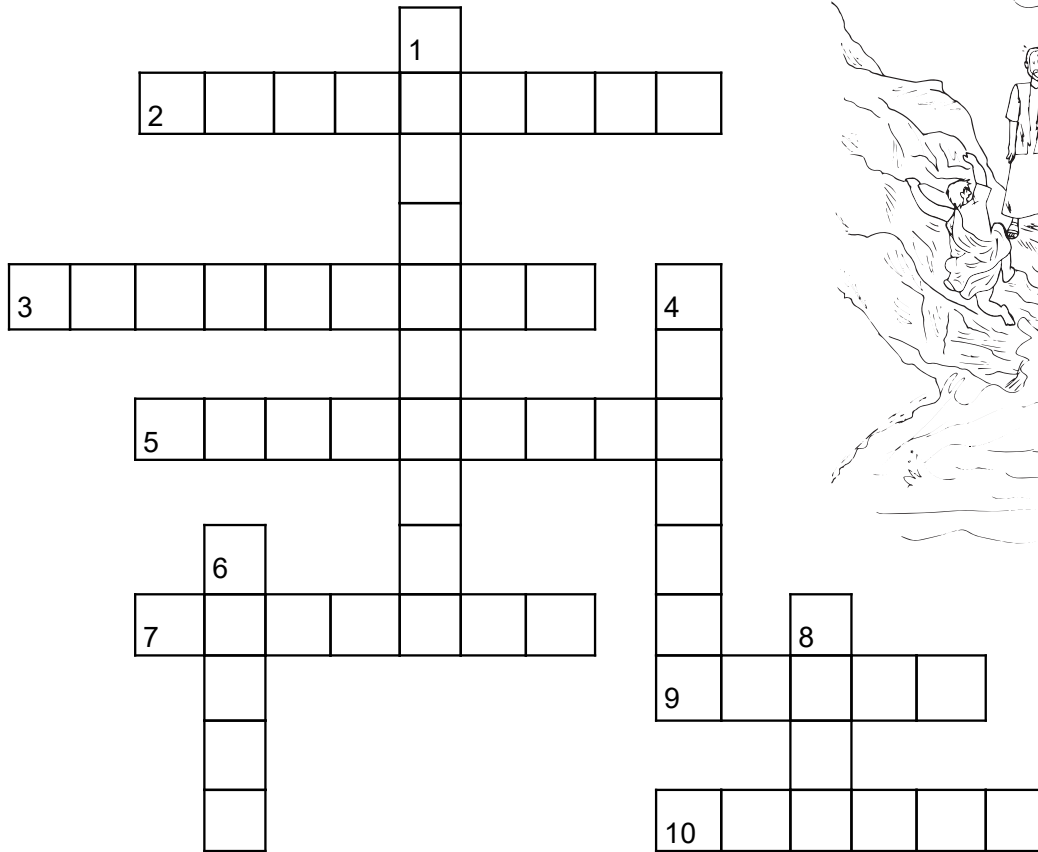

Across

2. The soldiers didn't want the _____ to escape so they planned to kill them since the ship wrecked on the shore.
3. Man that was a Gentile that was baptized.
5. Day that the first sermon of the Church was preached
7. While Paul was under house arrest he used his time to write _____ .

9. Paul was bitten by this poisonous creature and did not die.
10. The centurion in charge of the prisoners.

Down

1. Because Paul had _____, the men were encouraged
4. These men were very hospitable to the men who were shipwrecked.
6. Preached the first sermon of the Church
8. Was the apostle to the Gentiles

Answer Key

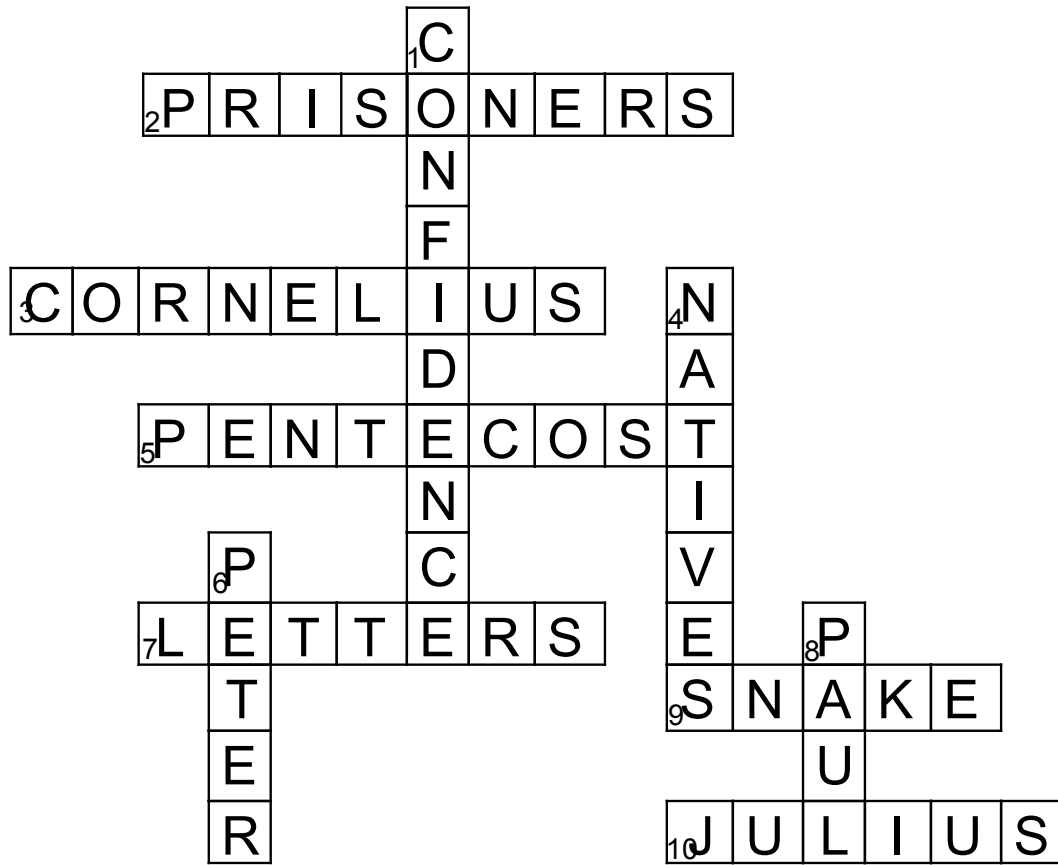

Across

2. The soldiers didn't want the _____ to escape so they planned to kill them since the ship wrecked on the shore.
3. Man that was a Gentile that was baptized.
5. Day that the first sermon of the Church was preached
7. While Paul was under house arrest he used his time to write _____ .

9. Paul was bitten by this poisonous creature and did not die.
10. The centurion in charge of the prisoners.

Down

1. Because Paul had _____, the men were encouraged
4. These men were very hospitable to the men who were shipwrecked.
6. Preached the first sermon of the Church
8. Was the apostle to the Gentiles